

3.2

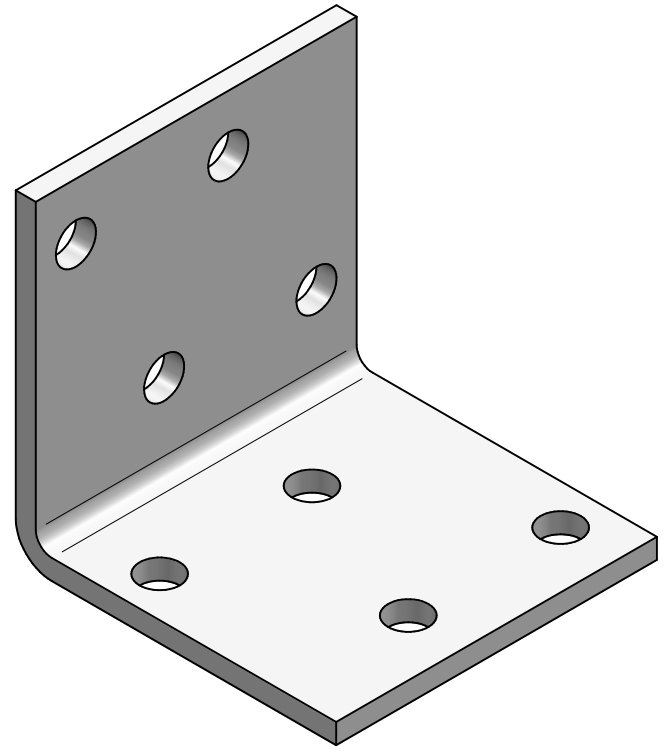
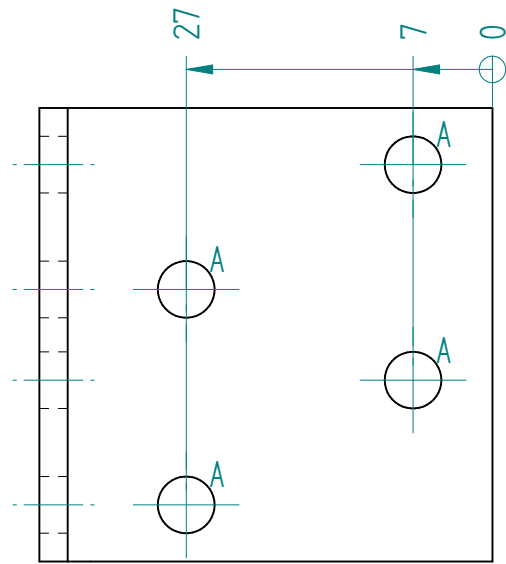
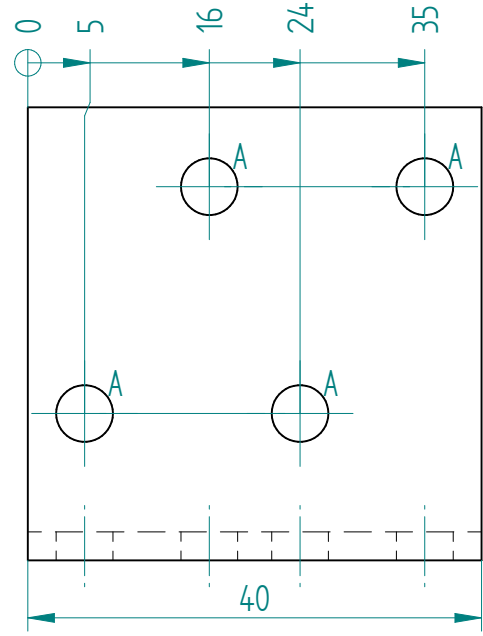
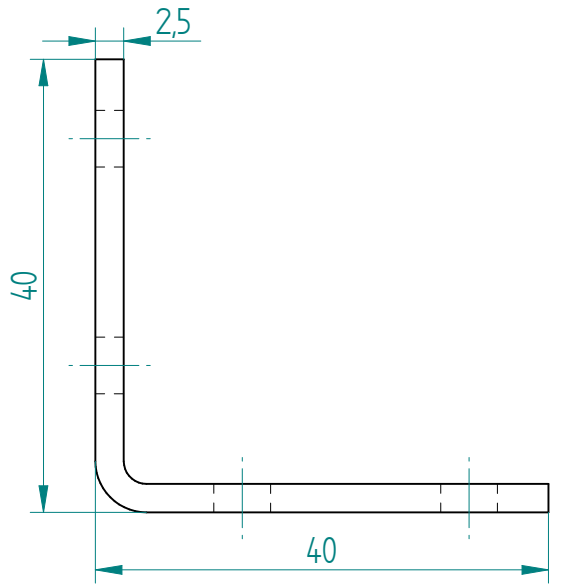

Hole	Size	Count
A	5 mm	8

**Product name:** Angle bracket 40x40x40x2,5  
**Material:** HDG DX51D Z275